

blofield®

AIR DESIGN



Manual for Very Big Blo



Thank you for purchasing your Blofield® Very Big Blo. In a few minutes you will be able to enjoy your new Blofield®. It is your responsibility to carefully read and use this manual, which contains important information concerning your safety and the maintenance of this product. We recommend that you keep the manual for future reference.

We hope you enjoy your Blofield®!

[www.blofield.com](http://www.blofield.com)

---

## Content

<b>Important information</b>	<b>3</b>
<b>1 - Inflating the Blofield</b>	
Preparation	4
The sofa	6
The cushion	8
<b>2 - Deflating the Blofield</b>	
The sofa	10
The cushion	12
<b>3 - Folding</b>	<b>14</b>
<b>4 - Maintenance</b>	<b>15</b>
<b>5 - Problem solving</b>	<b>16</b>
<b>6 - Warranty</b>	<b>17</b>
<b>7 - Contact</b>	<b>18</b>



## Important information

---

**Please read all safety instruction carefully in order to prevent injury.**

**Warning:** The Blofield® is not a toy or a bouncing pillow.

**Warning:** The pump is an electrical product, not a toy. To avoid the risk of injury, it is not allowed to play with the pump. Do not use the electrical pump near water and do not bring the pump in contact with water. Remove the plug from the socket when the pump is not being used.

**Warning:** After inflating, store the pump outside the reach of children.

**Warning:** Do not use a compressor to inflate your Blofield®. Only use pumps delivered by Blofield®.

- The product is not designed to be used in water, or as a life-saving appliance.
- In no event shall Blofield® be liable for any direct, indirect, punitive, incidental, special consequential damages or personal injuries arising out of or connected with the misuse of its products.
- When using the Blofield®, place it in a safe environment and check this for sharp edges, stair steps or breakable objects. Only use on flat surfaces.
- Despite the nylon reinforcements on the bottom of the Blofield®, it is necessary to remove all sharp objects from the area where the sofa will be inflated and used. Do not use the Blofield® on a rough surface.
- Do not use sharp objects in the sofa, and mind sharp objects on clothing (belts, buttons, zippers) that may damage the Blofield®.
- The sofa is made of synthetic material and can melt when exposed to heat or open fire. Do not place the sofa near heating elements, open fire or other hot objects.
- Do not walk or jump on the sofa, or use it as a trampoline. This could cause a leak in the Blofield®.
- The Blofield® Very Big Blo is designed for usage by a maximum of 4 adults, do not seat more people on the sofa.
- After you have inflated the Blofield® Very Big Blo, it is possible that temperature fluctuations cause a difference of air pressure in the sofa. This is normal. You can use the pump to restore air pressure in the Blofield®.
- If the pump's electricity cable is damaged, it must be replaced by Blofield® in order to avoid dangerous exposure.
- Use the pump in a clean environment, away from sand, water, leaves or grass. When inflating, the unused opening of the pump will suck in air; make sure that the pump does not suck in any sand or other dirt.
- Make sure that your hands are dry when inserting the pump's plug in the socket. Do not use the pump near water.
- Do not attempt to disassemble, repair or service the pump. There are no parts in the pump that can be maintained by yourself.

# 1 - Inflating the Blofield: Preparation

Please read the following points carefully before inflating your Blofield Very Big Blo.

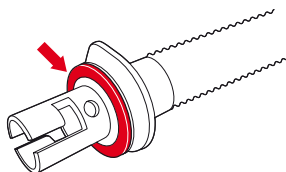
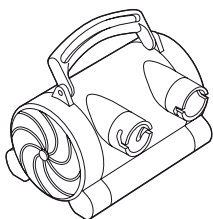
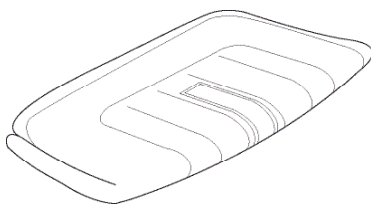
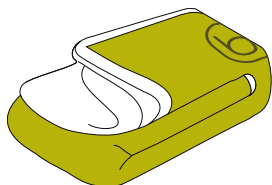

The following parts must be present:

- sofa
- cushion
- Blofield pump
- pump hose, with rubber ring attached to the nozzle of the hose

## 1 Check if the valves are closed

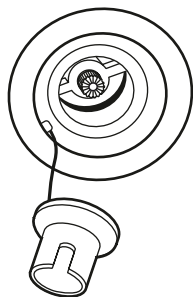

valve open

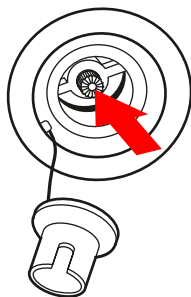

press the small knob

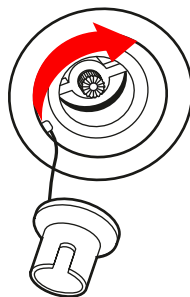

turn it a quarter turn

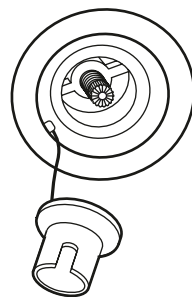

valve closed

To check if the valves of the sofa and cushion are closed, first twist off the caps from the valves. If the valve is open, then press the small knob and turn it a quarter turn, the valve will be closed.

---

② Placing the nozzle

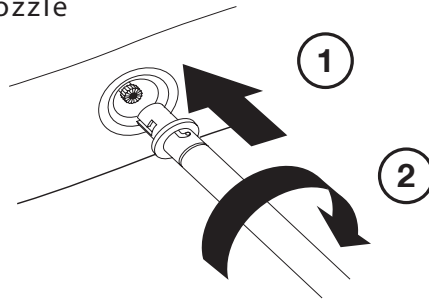

For a good connection, the nozzle must be placed straight in the valve and be turned round clockwise. Do not force the connection, or the valve or hose-nozzle might be damaged.

---

③ Connect the hose to the pump

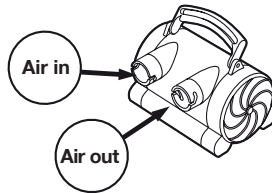

For inflating, connect the hose to the pump at AIR IN.

---

④ Disconnect the nozzle first, before switching off the pump

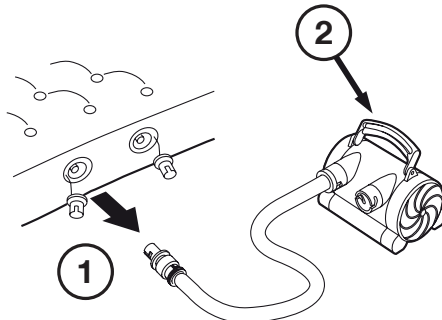

When inflating the Blofield, always disconnect the nozzle from the valve first, and then turn off the pump, otherwise the sofa will deflate.

# 1 - Inflating the Blofield: the sofa

---

- ① Step 1: Twist open the valve-caps

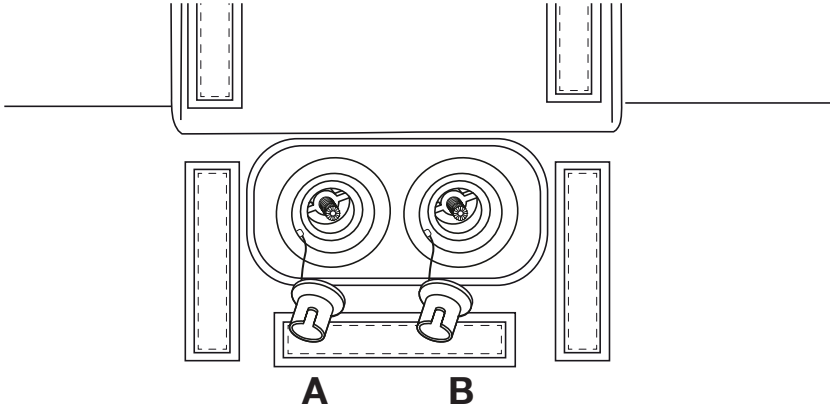

Unfold the sofa, open the valve cover at the back of the sofa, and twist open valve caps A and B.

---

- ② Step 2: Inflate A-chamber 75%

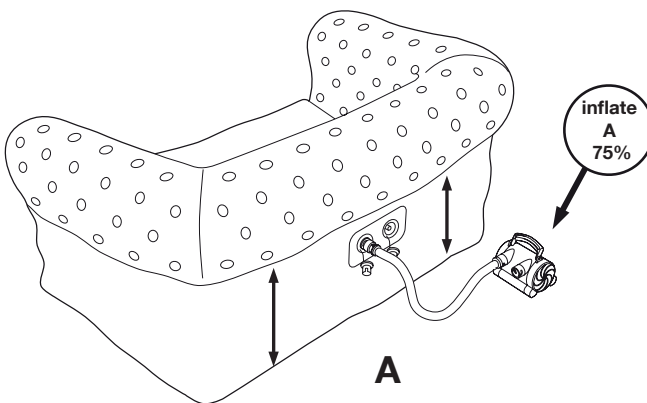

Connect the nozzle of the hose to valve A. Turn on the pump, the main volume of the sofa will now be inflated. Partially inflate the main volume, to 75%. This will take approximately 2 minute and 10 seconds.

**3** Step 3: inflate B-chamber 100%

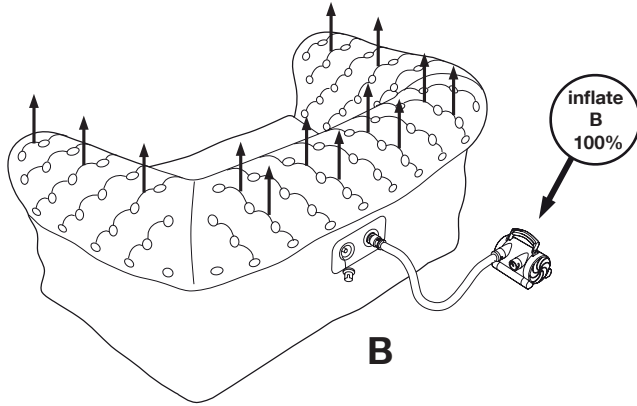

Now connect the nozzle to valve B to inflate the “chesterfield-effect”. Fully inflate this volume (100%). This will take approximately 40 seconds.

**4** Step 4: inflate A-chamber 100%

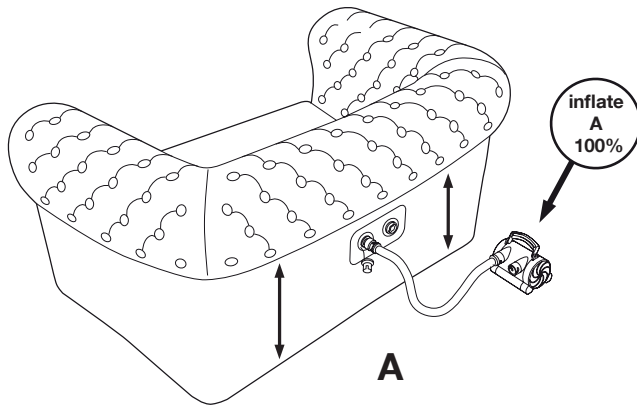

Connect the nozzle to valve A again, en inflate the main volume to 100 %. This will take approximately 30 to 40 seconds. Remove the nozzle from the valve and turn off the pump. Then, place the valve caps on the valves.

# 1 - Inflating the Blofield: the cushion

---

## ① Step 1: Twist open the valve-caps

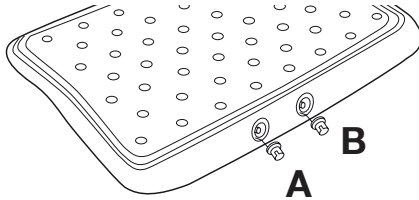

Unfold the cushion, and twist open valve caps A and B.

---

## ② Step 2: inflate A-chamber 75%

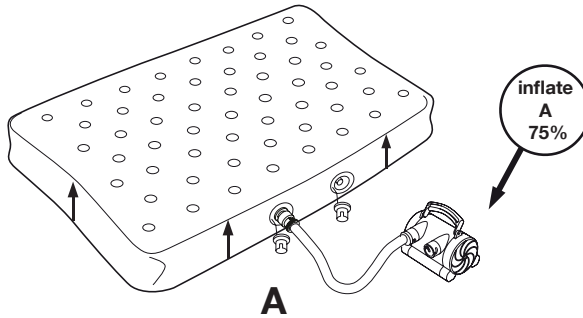

Connect the nozzle of the hose to the A valve. Turn on the pump, the main volume of the cushion will now be inflated. Partially inflate the main volume, to 75%. This will take approximately 20 seconds.

---

## ③ Step 3: inflate B-chamber 100%

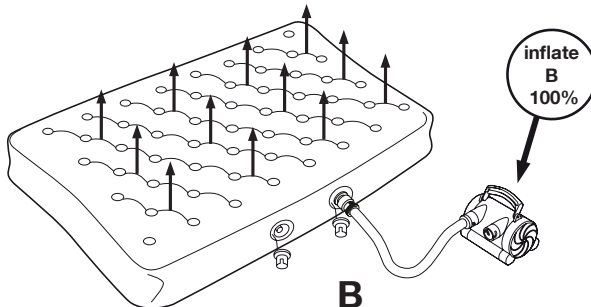

Now connect the nozzle to valve B to inflate the "chesterfield-effect". Inflate this volume completely (100%). This will take approximately 15 seconds.



---

④ Step 4: inflate A-chamber 100%

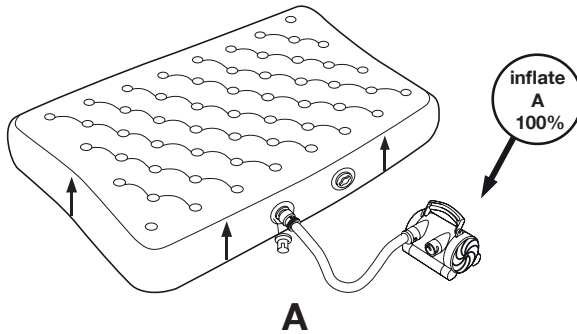

Connect the nozzle to valve A again, and inflate the main volume to 100%. This will take approximately seconds. Remove the nozzle from the valve and turn off the pump.

---

⑤ Step 5: finish

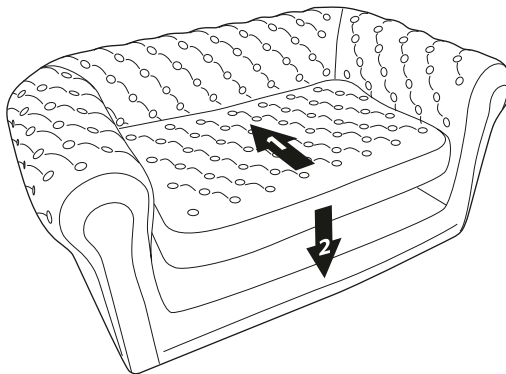

Place the valve caps on the valves.

Place the cushion on the sofa. Push the cushion back in the sofa as far as possible without the cushion's velcro touching the sofa, then push the cushion down.

Should you encounter any problems while inflating your Blofield®, we direct you to chapter 5 - Problem solving (page 16).

## 2 - Deflating the Blofield: the sofa

---

### 1 Step 1: Twist off the valve caps

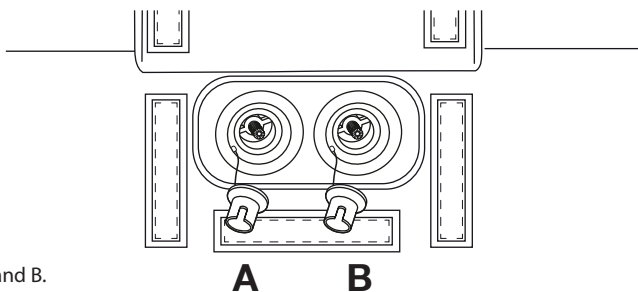

Twist off valve caps A and B.

### 2 Step 2: Open the valves to release air

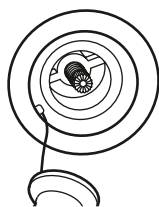

valve closed

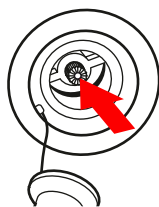

press the small knob

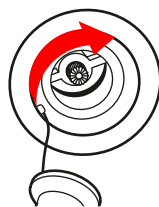

turn it a quarter turn

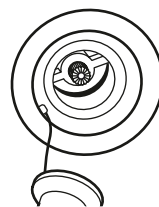

valve open

In order to deflate the sofa in the fastest way, the valves can be opened. To open the valve, press the small knob and twist it 90 degrees. Open valve A as well as valve B.

### 3 Step 3: Press the sofa to a compact shape

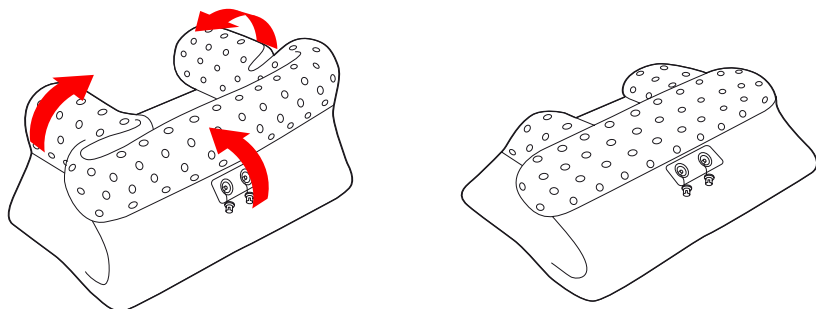

Push out the air by pressing the sofa. Make sure that the armrests will be put inwards, and that the backrest will be on top of it, see picture. This will make it easier to fold the sofa in the right way.

#### 4 Step 4: close the valves again

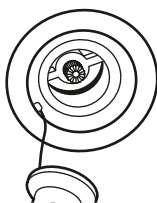

valve open

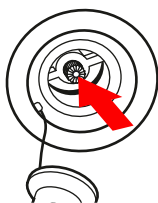

press the small knob

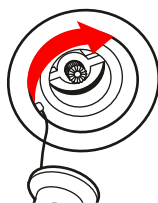

turn it a quarter turn

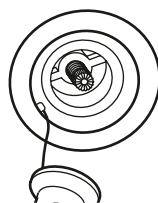

valve closed

After the air has left the chair, (after about 1 minute after opening the valves) twist both valve knobs back 90 degrees, so that the valve is closed again.

When the valves are not closed, the sofa can not be deflated properly, when using the pump.

#### 5 Step 5: deflating chamber B

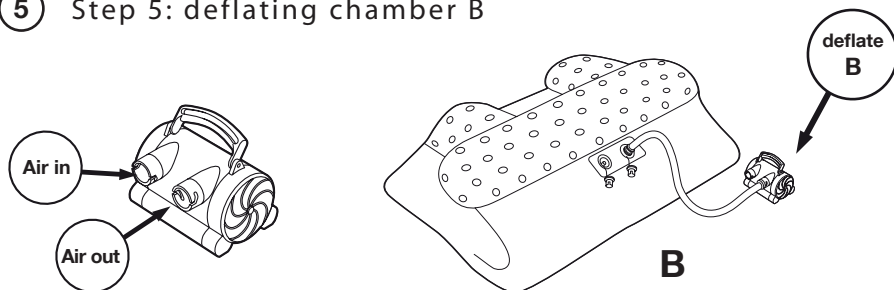

Check if the hose is connected to the pump at 'AIR OUT'. Connect the nozzle of the hose to valve B of the sofa. Turn on the pump, the "chesterfield-effect" will now be sucked vacuum. This will take between 35 - 45 seconds. Keep the pump switched on when disconnecting the nozzle of the hose from the valve.

#### 6 Step 6: deflating chamber A

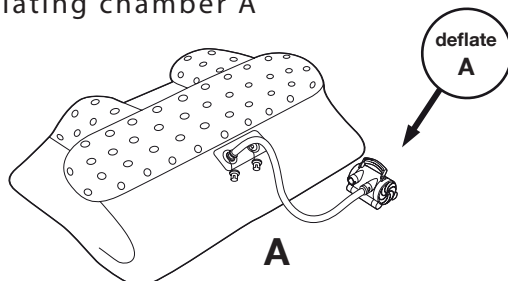

Now connect the nozzle of the hose to valve A. The main volume will now be sucked vacuum. This will take about 1 minute and 50 seconds. Disconnect the nozzle from the valve and turn off the pump.

At last, place the valve caps back on the valves. The Blofield® is now completely empty and can be folded.

## 2 - Deflating the Blofield: the cushion

---

- ① Step 1: Twist off the valve caps

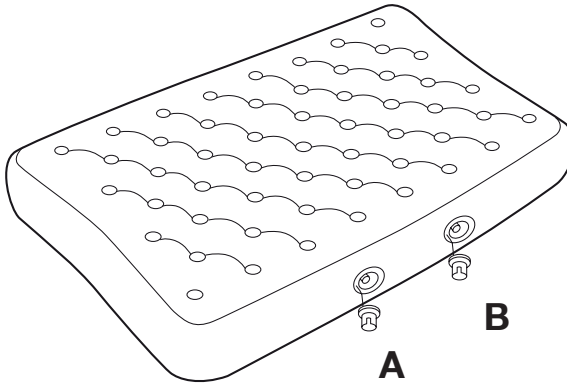

Twist off valve caps A and B.

---

- ② Step 2: Press the valves to release air

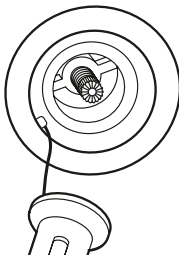

valve closed

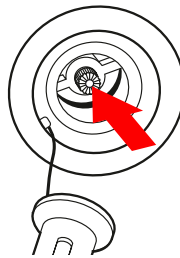

press the small knob

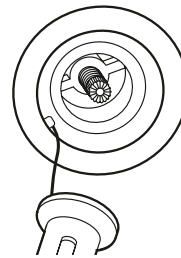

release the knob;  
valve is closed again

Press the valves to release most of the air inside. Just press the small knob and hold it for 10-15 seconds, press valve A as well as valve B. Make sure the valves are closed after releasing air, when they are not, the cushion can not be deflated properly using the pump.

③ Step 3: Deflate B-chamber using the pump

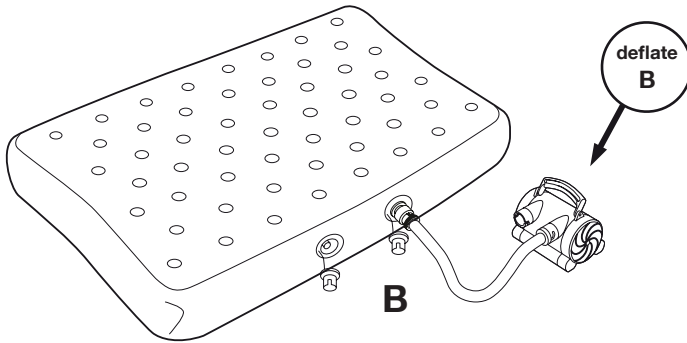

Check if the hose is connected to the pump at AIR OUT. Connect the nozzle of the pump to valve B of the cushion. Turn on the pump, the "chesterfield-effect" of the cushion will now be sucked vacuum. This will take approximately 15 seconds.

④ Step 4: Deflate A-chamber using the pump

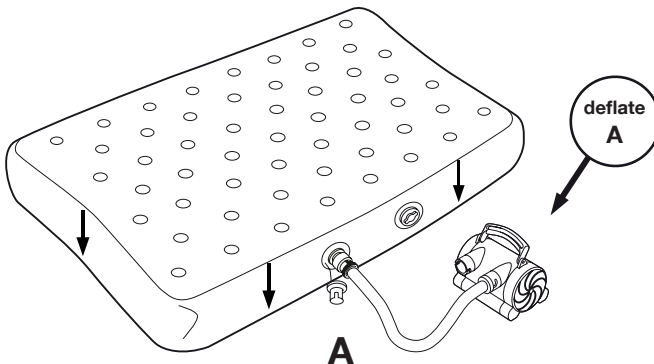

Now connect the nozzle of the hose to valve A of the cushion. Turn on the pump, the main volume will now be sucked vacuum. This will take approximately 20 seconds. Then, place the valve caps on the valves.

### 3 - Folding

---

#### ① Step 1: Folding the cushion

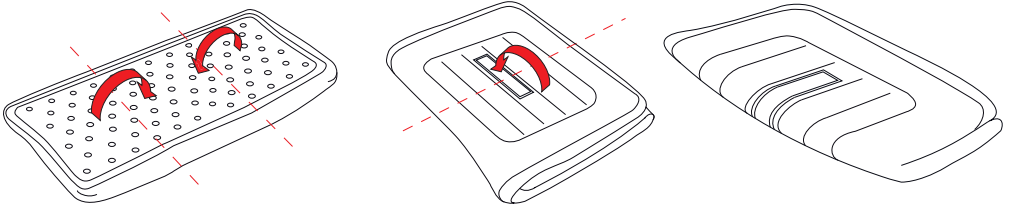

Check if the caps are twisted on the valves, then fold the cushion as shown above.

---

#### ② Step 2: Folding the sofa

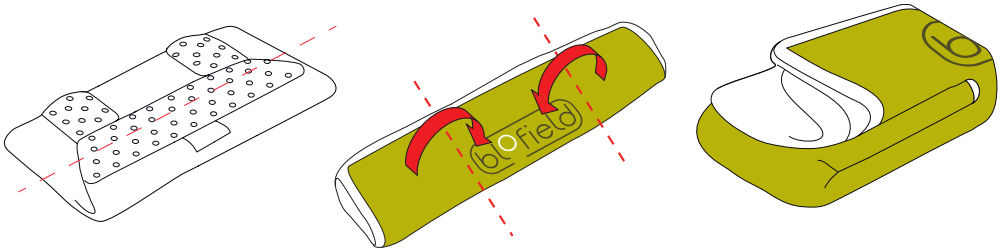

Check if the caps are twisted on the valves, then fold the sofa as shown above.

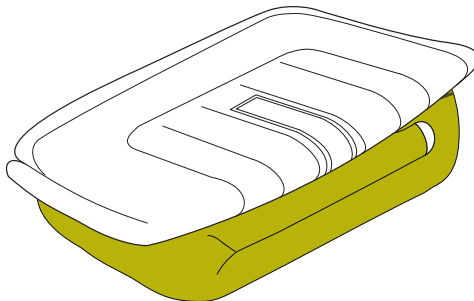

## 4 - Maintenance

---

### **Cleaning**

- For routine cleaning, the easiest way to clean the Blofield is to deflate the B chamber of the sofa and the cushion (while chamber A remains inflated). The Blofield will have a smooth surface, which makes it easier to clean.
- The chair can be cleaned by using water and soap, or order the Blofield Sofa cleaner at the customer service: [service@blofield.com](mailto:service@blofield.com). This cleaning liquid is specially designed for Blofield®. Do not use aggressive or chemical detergents.
- Blofield Sofa Cleaner (750ml) instructions;  
For every dirty surface or ingrained dirt, spray the detergent onto the surface to be treated; leave for a few minutes and then wipe with the sponge. Rinse with water and dry with the cloth.
- Using the Blofield Sofa Cleaner, it is easy to remove the most common dirt. When the seating area has blue spots caused by jeans, try to remove the spots as soon as possible, preferably within 1 day. This blue ink can not be removed after a while without leaving unremovable marks on the product.
- Preferably, do not place the Blofield® under trees that drop resin, seeds or fruits: this can cause filthiness which is difficult, or impossible to remove.

### **Packing**

- Do not pack the Blofield® when wet; let the sofa dry first.
- When packing the sofa, make sure that all the valves are capped.

### **Storing**

- If the sofa is not used for a long period of time, deflate the sofa and store it. Make sure the product is completely dry before folding and storing it.
- Store the Blofield® at room temperature (over 10°C), in a clean and dry environment. If the Blofield is stored in temperatures under 10°C, or over 40°C, this can affect its functioning, which will not be covered by the warranty.

## 5 - Problem solving

### If the Blofield® does not inflate

- Always check if the hose is connected to the pump at AIR IN; inflating, and not to AIR OUT. The AIR OUT connection is to be used to suck the Blofield® vacuum.
- When air leaks from the nozzle when inflating, check if the nozzle is attached properly, see page 4, step 2. If this is the case, then check if the nozzle contains a rubber ring; see page 4, top of the page. If this is damaged or missing, contact our Customer Service.

### If the Blofield® is deflating

- If the sofa is losing air directly after you inflated it for the first time, check if the valves are closed, see next bullet.
- Check the position of the small twist-knob on the valve. The small twist-knob of the valve must at all times be in an outward position when the valve is closed. When the twist-knob is turned inward, the valve is open and the chair will deflate immediately. Close the valve by pushing the twist-knob and twisting it a quarter-turn. The twist-knob will now come out, in the right position. See page 4, step 1 for more details.

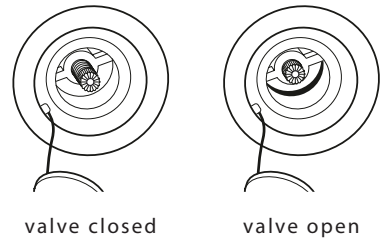

If the valve is closed, and air is still leaking from it, contact the Blofield Customer Service.

- If the sofa suddenly deflates after normal use, check if the Blofield® has a leak and contact the Blofield Customer Service. Small leaks can be found by spraying the sofa with water, using a spray-bottle. For repairing a leak, Blofield® can provide a repairkit with a repair-manual.
- If you use the Blofield® for long periods of time, there is a possibility that the sofa will start losing pressure after a while. This is normal. The air pressure in the sofa fluctuates because of temperature changes. You can use the pump to restore air pressure in the Blofield®.

### If the pump is not working

- Check if there is voltage on the socket by plugging in a different electrical appliance. If the pump is plugged in, and the switch is turned on, the pump should be working. If this is not the case, contact the Blofield Customer Service.

### If the Blofield® is creased

- Because the Blofield® is an inflatable product, it will only reach the optimal form some time after having been inflated. After unpacking and inflating, the sofa might be a bit creased, because the Blofield® has been folded as compact as possible after production. If you partially deflate and then fully inflate the sofa for a few times over the course of the next hours, the creases will disappear.

**Blofield Customer Service: [service@blofield.com](mailto:service@blofield.com)**



## 6 - Warranty

---

Blofield® guarantees the Blofield® sofa and pump to be free from material and workmanship defects for a period of one (1) year from the date of its purchase by the customer. If, during this warranty period, the product proves defective due to improper materials or workmanship, please contact Blofield®. Blofield® will repair or replace the product based on the terms and conditions set out below, providing the product has been used for the purposes outlined in these manuals and operated according to all instructions provided.

### **Conditions:**

I. The warranty will only be granted when the original invoice or sales receipt (indicating the date of purchase and dealer's name) is presented together with the defective product. Blofield® reserves the right to refuse the warranty service if the above documents cannot be presented or if the information contained in them is incomplete or illegible.

II. This warranty will not reimburse nor cover the damage or modification resulting from adaptations or adjustments which may be made to the product, without Blofield®'s prior written consent.

III. This warranty covers none of the following:

- a. Periodic maintenance, repair or replacement of parts due to normal wear and tear;
- b. Any adaptation or changes to upgrade the product from its normal purpose as described in the instruction manual, without Blofield®'s prior written consent;
- c. Transport costs and all risks associated with transport relating directly or indirectly to the warranty of the product;
- d. Damage resulting from:
  1. Misuse, including but not limited to (a) failure to use the product for its normal purpose or in accordance with Blofield®'s instructions on the proper use and maintenance and (b) installation or use of the product in a manner inconsistent with the technical or safety standards in force in the country where it is used and (c) improper or incorrect installation of the product.
  2. Repairs done by parties others than approved Blofield® staff or the customer himself;
  3. Accidents, lightning, water, fire or any other cause beyond Blofield®'s control.

IV. This warranty does not affect the customer's statutory rights under applicable national laws in force, or the customer's rights against the dealer arising from their sales/purchase contract. All customers must obtain an authorisation from Blofield® before returning a defective product.

© 2009 - 2013 Blofield®. All rights reserved.

## 7 - Contact

---

The Blofield Customer Service can be reached with the following information.

**Blofield Customer Service**

[service@blofield.com](mailto:service@blofield.com)

[www.blofield.com](http://www.blofield.com)

---

### **Environmental protections**

Electrical products are not to be processed as household refuse. When relevant facilities are available, you can have the product recycled. Ask your municipality or retailer for advice.



### **Intellectual Property**

All intellectual property rights in relation to the product, including but not limited to, author's rights and model rights, lie with the manufacturer, Blofield® and it is not allowed to either wholly or partially copy, make public or imitate the product without the expressed prior written consent from the legal owner.

The name and the Blofield® logo are registered Blofield® trademarks.



**AIR DESIGN**

VBB Consumer Manual

Version 2.3

© 2012 Blofield, The Netherlands

[www.blofield.com](http://www.blofield.com)